

 **The only reason for Hangke exists is to serve customers.**

HANGZHOU HANGKE OPTOELECTRONICS GROUP CO., LTD.

Web: www.hkled.com

Tel: +86-571-89986666

Head Office: 33rd Floor, #4 Building of EFC, No. 1118 Xiangwang Street, Yuhang District, 311121 Hangzhou, China.

Factory: Xinglong Road, Tongcheng Technical Economic Development Zone, 231400 Anqing City, Anhui, China.

2020



HANGKE

Professional Filament Bulb and SKD Supplier

Industry-leading

High colour rendering bulbs,
product series with CRI > 95.

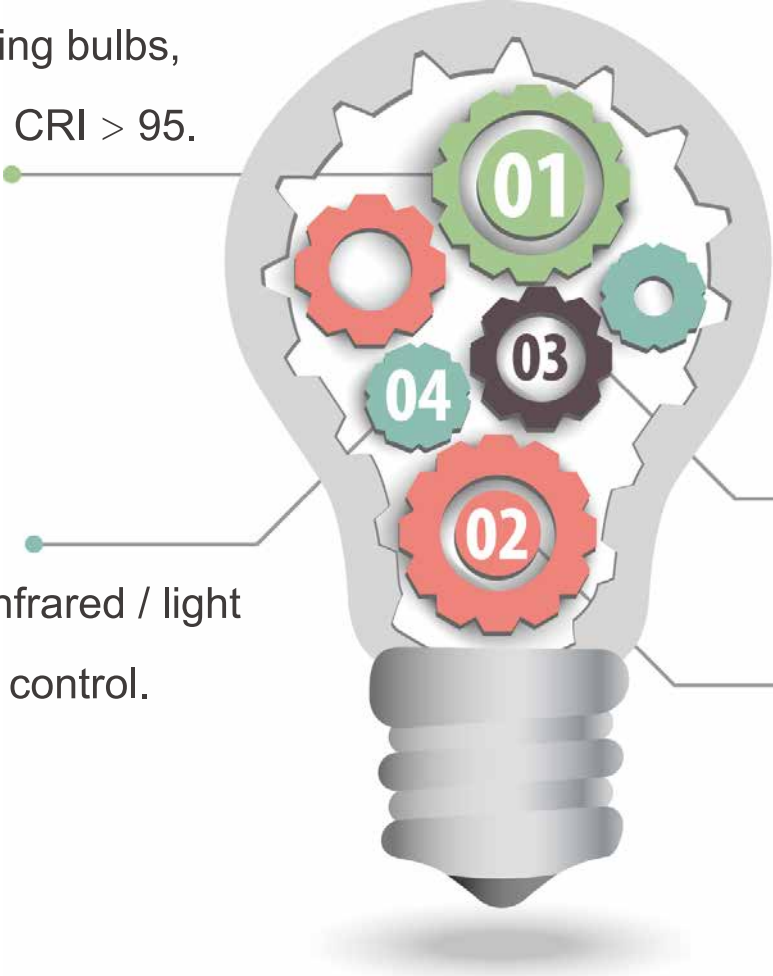

Smart bulbs, compatible with
Wifi / Bluetooth / Zigbee.

Functional bulbs, infrared / light
sensation / remote control.

High-power linear dimmable
bulbs, up to 1600LM for North
America and 2542LM for Europe.

COMPANY PROFILE

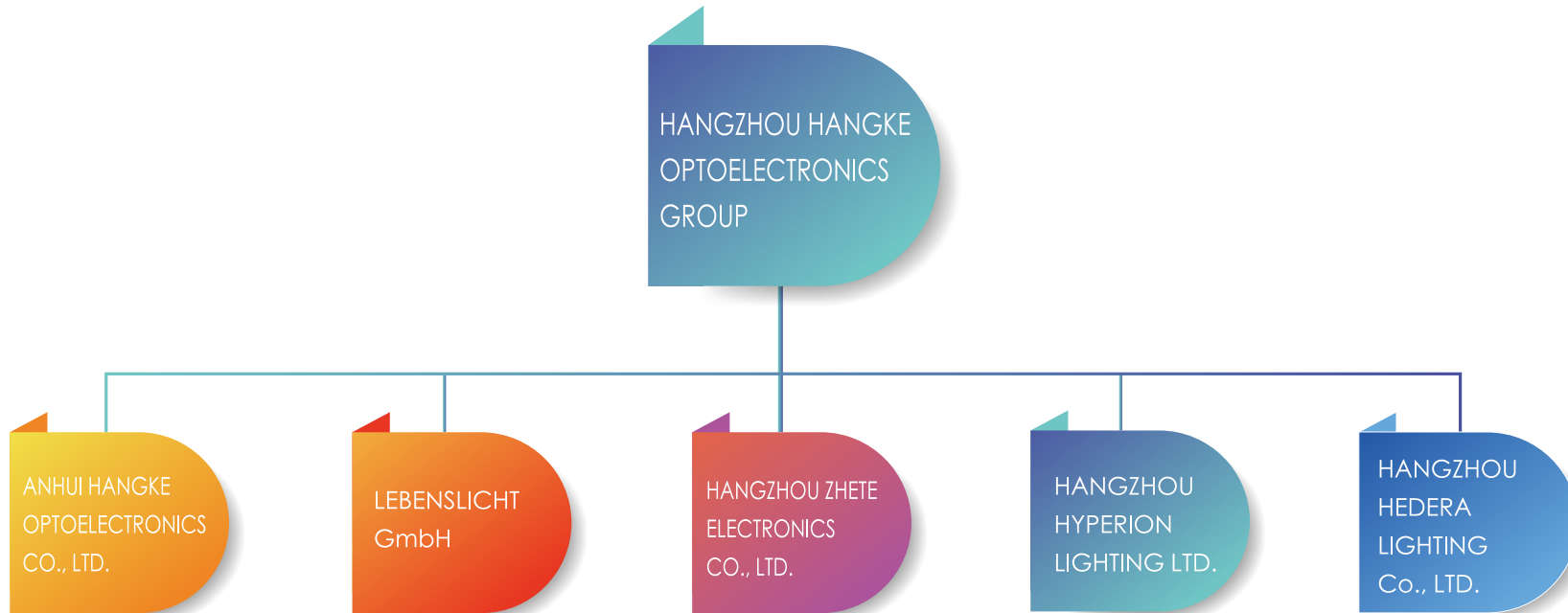

HangKe Optoelectronics is a world-leading technology company specializing in the research and development, manufacturing and sales of LED Filament Bulbs and related components, provide customers with large-scale, high-quality filament bulbs ODM services.

We are a manufacturer of filament bulbs and components with highly vertical industrial chain integration advantages. Filaments, bulb shells, stems, and drivers are all produced by ourselves. The vertical industrial chain makes the quality process control more strict, the production delivery faster, and the product cost performance more advantageous. HangKe Optoelectronics currently has 35 production lines for Finished Bulb and 120 production lines for Filament Packaging, the maximum production capacity is 10 million/month of filament bulbs and 50 million/month of filament strips. HangKe has established long-term and large-scale cooperation with international brands such as Signify, Ledvance, Feit, etc. HangKe owns more than 100 patents, and obtained the the finished bulb patent and filaments patent authorizations. The products are fully certified in the European and North American markets.





X-Ray



Function: Observe the internal structure of the sample by X-Ray without damaging the sample (Wire Bonding, Leadframe etc.). Can check the LED porosity after reflow process.

SUG61005BG-Surge Test



Function: For testing of the Electrical appliance working condition when the appliance is suffered sudden switch or nature strikes.

ESPEC Thermal Shock Chamber



Function: Test the performance and property for electrical, electronics and other material with environmental changes at high / low temperature, damp heat or constant temperature changes.

ESPEC Damp Heat Test Chamber



Function: To simulate the continuous environment of high / low temperature to detect the chemical changes or physical damage caused by thermal expansion and contraction.

Certification

Factory Qualification



Product Certification

Europe



Northern America



Patent

Ledisong patent

Samsung patent

Manufacturing Plant



Automatic Production Line



Automatic Spot Welding

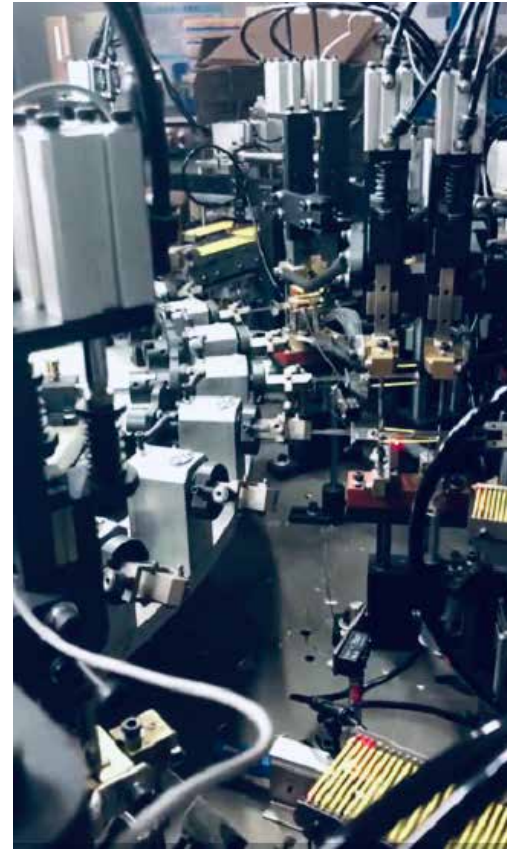

Spot Welding



Online Light-up Test

Filament LED Packaging



Die Bonding



Wire Bonding



Phosphor Dispensing

Glass Bulb Manufacturing



Glass Pipe Loading



Blowing



Shaping



Bulb Coating

Stem and Welding Manufacturing



Burning



Glazing



Wire Soldering



Spot Welding

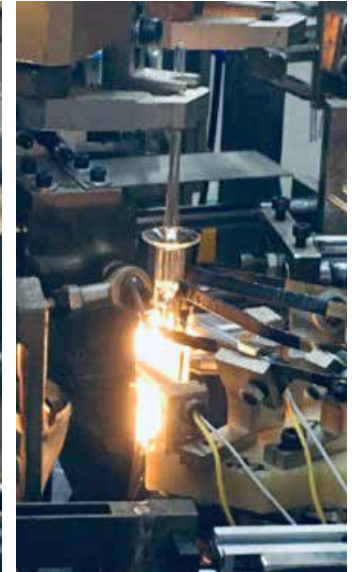

Light-up Test

Driver Assemble



SMT Workshop



Wave Soldering Workshop



Driver Assembly Line

Smart Lamps





- Microphone function.
- Compatible with Alexa and Google Home.

Bulb type	Voltage	Lumen	CRI	Base
A60	230 V	470 lm	80/90	E27
A60	230 V	806 lm	80/90	E27
A19	120 V	500 lm	80/90	E26
A19	120 V	800 lm	80/90	E26

Bluetooth Control



- Controllable with effective distance 15m.
- CCT and Brightness Dim.
- Compatible with Alexa and Google Home .

Bulb type	Voltage	Lumen	CRI	Base
A60	230 V	470 lm	80/90	E27
A60	230 V	806 lm	80/90	E27
A19	120 V	500 lm	80/90	E26
A19	120 V	800 lm	80/90	E26

Zigbee Control



- Microphone function.
- Compatible with Alexa and Google Home.

Bulb type	Voltage	Lumen	CRI	Base
A60	230 V	470 lm	80/90	E27
A60	230 V	806 lm	80/90	E27
A19	120 V	500 lm	80/90	E26
A19	120 V	800 lm	80/90	E26

Brightness Step Dim

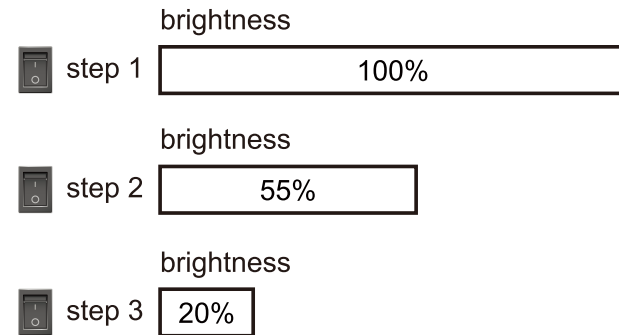

- Click Dimming Function.
- First step 100%, Second step 55%, Third step 20%.

Bulb type	Voltage	Lumen	CRI	Base
B35	230 V	470 lm	80/90	E14
A60/ST64	230 V	470 lm	80/90	E27
A60/ST64	230 V	806 lm	80/90	E27

Colour Step Dim



- Click Dimming Function.
- First step 2700K, Second step 4000K.

Bulb type	Voltage	Lumen	CRI	Base
B35/BA35/G45	230 V	400 lm	80/90	E14
A60	230 V	400 lm	80/90	E27
A60	230 V	806 lm	80/90	E27

Glow Dim

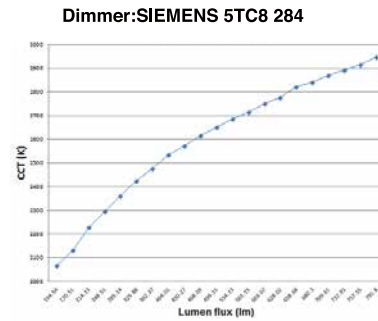

CCT: min 1700K - max 6500K
 lumen: min 90lm - max 806lm

Bulb type	Voltage	Lumen	CRI	Base
B35/G45	230 V	470 lm	80/90	E27
A60	230 V	470 lm	80/90	E27
A60	230 V	806 lm	80/90	E27

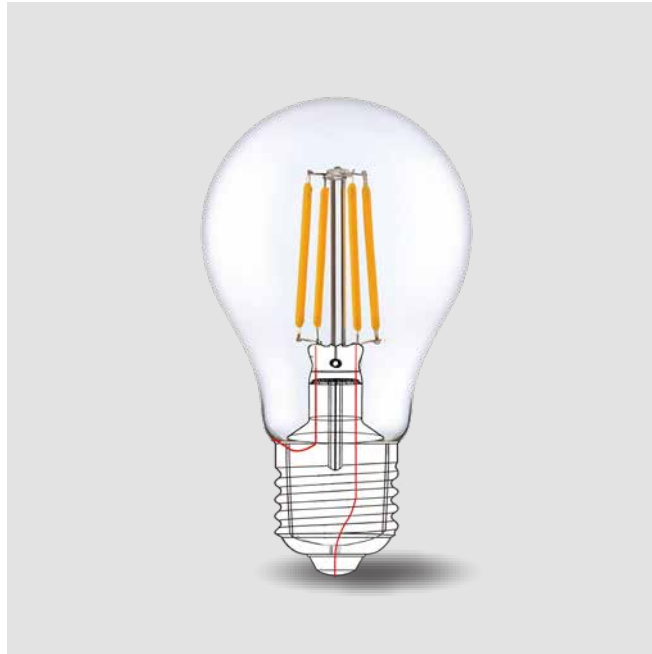

- Driver Free.
- Automatic production.
- Full Clear.
- Competitive cost.

Bulb type	Voltage	Lumen	CRI	Base
A60	230 V	470 lm	80/90	E27
A60	230 V	806 lm	80/90	E27

Full Spectrum Diagram

Item	Spectrum	Light color
Ordinary LED (4000K)		
Full Spectrum LED (4000K)		
Sunlight Spectrum LED (4000K)		



- Click Dimming Function.
- First step 2700K, Second step 4000K.

Bulb type	Voltage	Lumen	CRI	Base
B35/G45	230 V	470 lm	97	E14
A60	230 V	470 lm	97	E27
A60	230 V	806 lm	97	E27

Decorative Lamps

Decorative Lamps



Decorative Lamps



- Specially designed bulbs with spiral filaments.
- Style, quality and longevity.
- Nostalgic bulbs available for multiple shapes.
- Perfect vintage light for any application.

Decorative Lamps



- Specially designed bulbs with spiral filaments.
- Style, quality and longevity.
- Nostalgic bulbs available for multiple shapes.
- Perfect vintage light for any application.

Decorative Lamps



- Specially designed bulbs with spiral filaments.
- Style, quality and longevity.
- Nostalgic bulbs available for multiple shapes.
- Perfect vintage light for any application.

Decorative Lamps

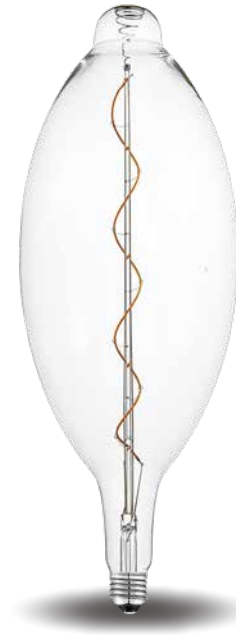
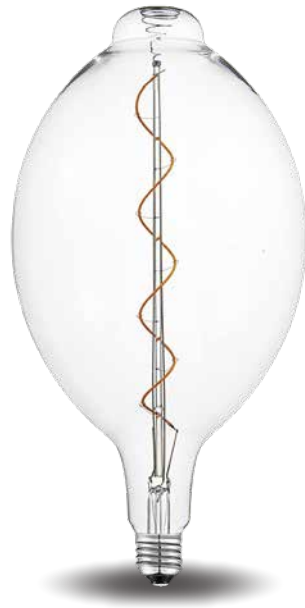

- Specially designed bulbs with spiral filaments.
- Style, quality and longevity.
- Nostalgic bulbs available for multiple shapes.
- Perfect vintage light for any application.

Colour Filament LED Lamps

Plant Growing Filament Bulb

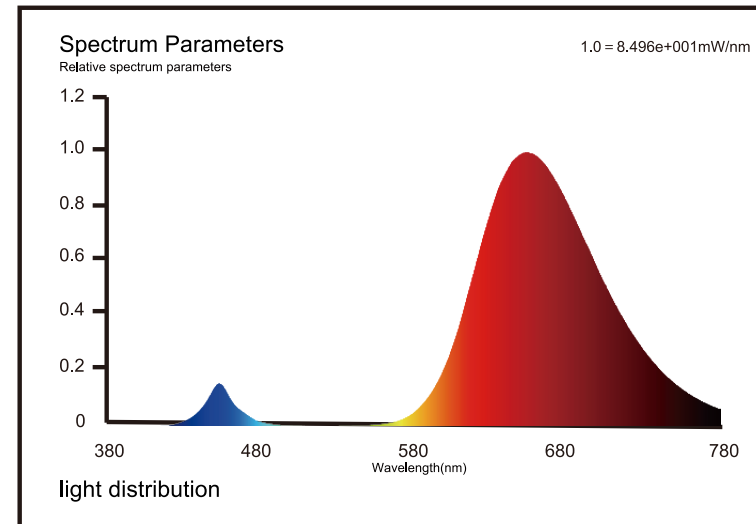

Full transparent.

Dual peak wave: 450nm & 660nm.

Red light stimulates flowering and seed germination.

Blue light promotes stem and leaf to grow.

Colour Filament LED Lamps



Coloured Glass Decorative mini globes, 6 Colours for Celebration.
Great for String Lights, Pendant lights or any fixture where the bulb is visible .

Colour Filament LED Lamps

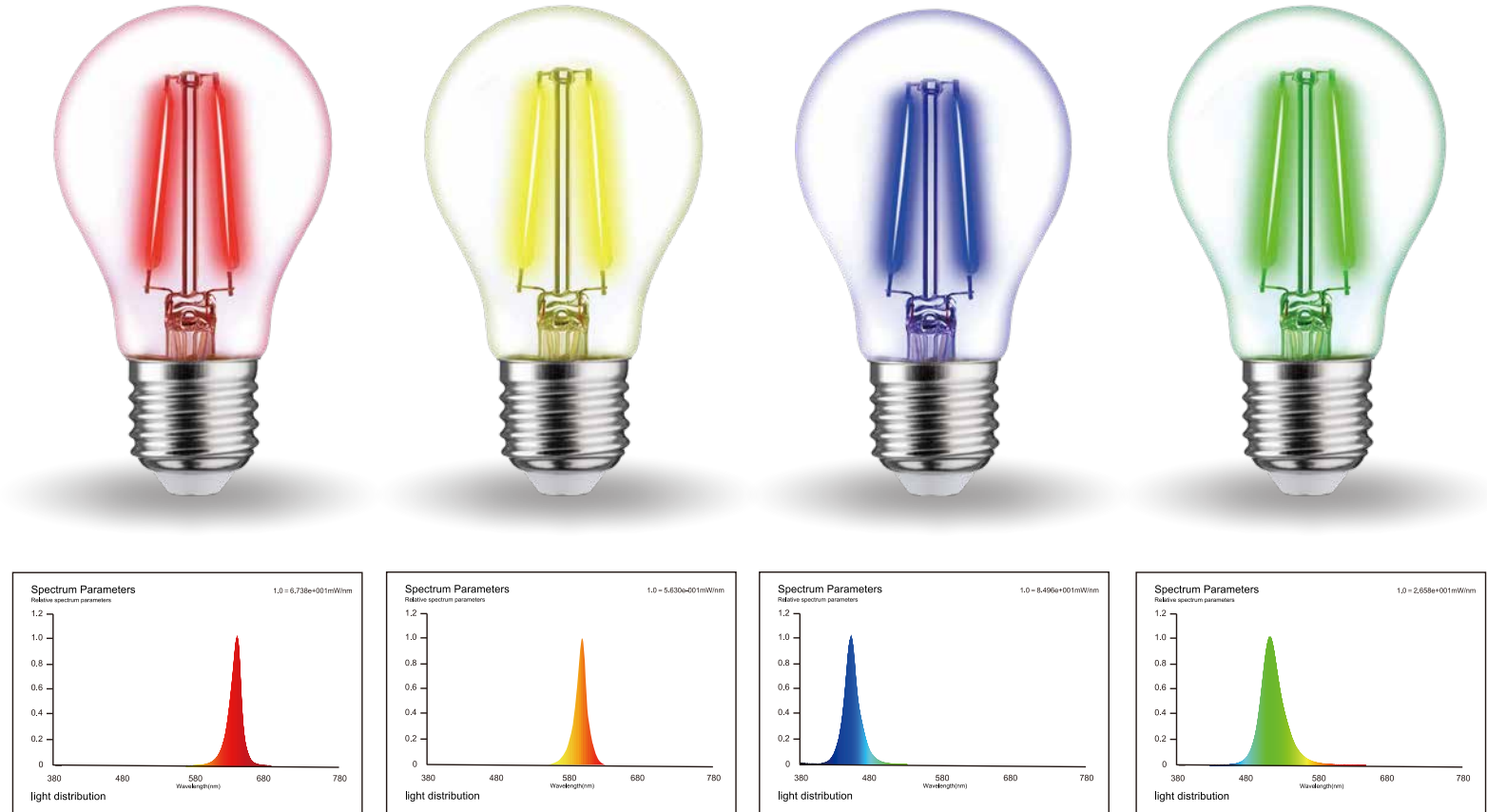

GAN chip technology makes various colour bulb available. The colour filament bulb are perfect for decoration, to create unique ambient evenings.

Mirror Head Lamps

G45 Mirror Head



Gold crown



Silver crown

Bulb type	Voltage	Lumen	CRI	Base
Gold crown	230 V	380 lm	80/90	E14
Silver crown	230 V	380 lm	80/90	E14

A60 Mirror Head



Gold crown



Rose crown



Silver crown

Bulb type	Voltage	Lumen	CRI	Base
Gold crown	230 V	380 lm	80/90	E27
Rose crown	230 V	380 lm	80/90	E27
Silver crown	230 V	380 lm	80/90	E27

G95 Mirror Head



Gold crown



Rose crown



Silver crown

Bulb type	Voltage	Lumen	CRI	Base
Gold crown	230 V	420 lm	80/90	E27
Rose crown	230 V	420 lm	80/90	E27
Silver crown	230 V	420 lm	80/90	E27

Filament LED Lamps General Bulbs

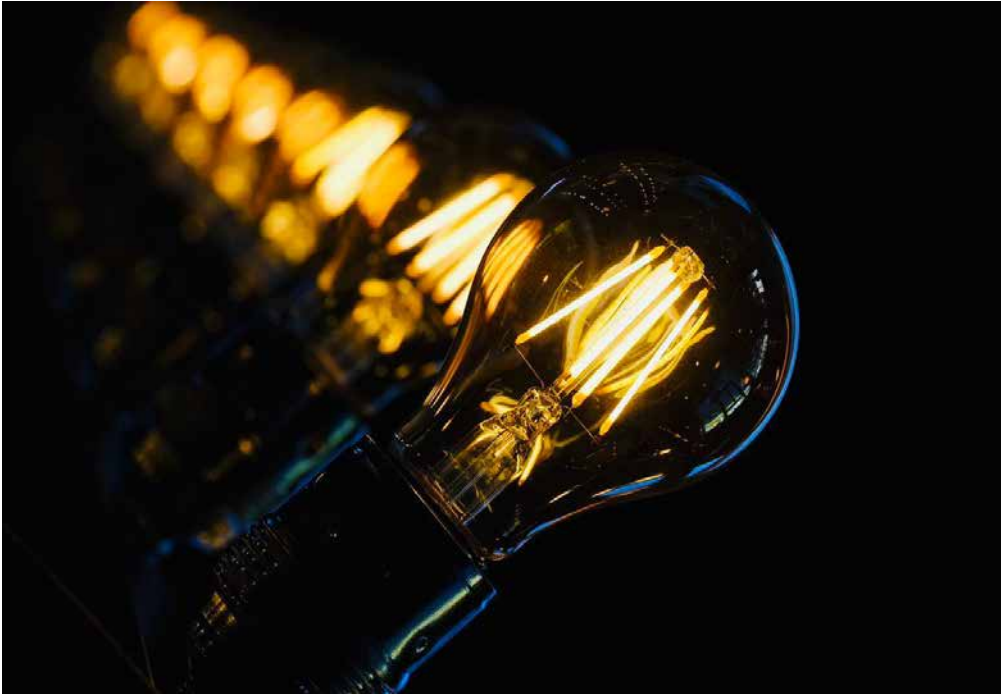

A60 / A19 Filament LED Lamps

Clear / Amber / Frosted / Milky / Silver Crown



A60 / A19 Clear



A60 / A19 Amber



A60 / A19 Frosted



A60 / A19 Milky



A60 / A19 Silver Crown

Product Size

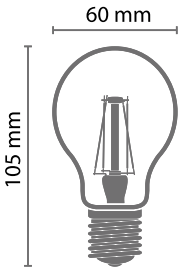

CCT Ref.



A60 / A19 Filament LED Lamps

Clear / Amber / Frosted / Milky / Silver Crown



Certification Europe



Non-dimmable version									
Bulb type	Finish	Voltage	Watt	Lumen	EQ Watt	CCT	CRI	Driver	Base
A60	clear	230V	4,3W/4,7W/5,2W	470 lm	40W	2700K/4000K/6500K	80/90/95	linear	E27/B22
A60	clear	230V	7W/7,5W /8,3W	806 lm	60W	2700K/4000K/6500K	80/90/95	linear	E27/B22
A60	clear	230V	8,5W/9,4W/10,3W	1055 lm	75W	2700K/4000K/6500K	80/90/95	linear	E27/B22
A60	clear	230V	10,5W/11,6W/12,7W	1521 lm	100W	2700K/4000K/6500K	80/90/95	linear/SMPS	E27/B22
A70	clear	230V	17W	2452 lm	150W	2700K/4000K/6500K	80	SMPS	E27/B22
Dimmable version									
Bulb type	Finish	Voltage	Watt	Lumen	EQ Watt	CCT	CRI	Driver	Base
A60	clear	230V	4,5W/5W/5,5W	470 lm	40W	2700K/4000K/6500K	80/90/95	linear	E27/B22
A60	clear	230V	7W/7,7W/8,5W	806 lm	60W	2700K/4000K/6500K	80/90/95	linear	E27/B22
A60	clear	230V	8,5W/9,4W/10,3W	1055 lm	75W	2700K/4000K/6500K	80/90/95	linear	E27/B22
A60	clear	230V	12W	1521 lm	100W	2700K/4000K/6500K	80	SMPS	E27/B22



Certification Northern America



Dimmable version									
Bulb type	Finish	Voltage	Watt	Lumen	EQ Watt	CCT	CRI	Driver	Base
A19	clear	120V	4,5W/5W/5,5W	450 lm	40W	2700K/5000K	80/90/95	linear	E26
A19	clear	120V	8W/8,8W/9,7W	800 lm	60W	2700K/5000K	80/90/95	linear	E26
A19	clear	120V	11W	1100lm	75W	2700K/5000K	80	linear	E26

G45/G16.5 Filament LED Lamps

Clear / Amber / Frosted / Milky / Silver Crown



G45/G16.5 Clear



G45/G16.5 Clear



G45/G16.5 Amber



G45/G16.5 Amber



G45/G16.5 Milky



G45/G16.5 Milky



G45/G16.5 Silver Crown

Product Size

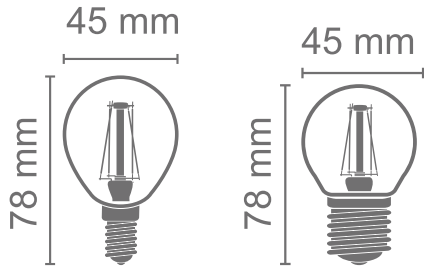

CCT Ref.



G45/G16.5 Filament LED Lamps

Clear / Amber / Frosted / Milky / Silver Crown



Certification Europe



Non-dimmable version 									
Bulb type	Finish	Voltage	Watt	Lumen	EQ Watt	CCT	CRI	Driver	Base
G45	clear	230V	1,5W/1,7W/1,9W	136 lm	15W	2700K/4000K/6500K	80/90/95	linear	E14/E27/B15/B22
G45	clear	230V	2,2W/2,4W/2,7W	250 lm	25W	2700K/4000K/6500K	80/90/95	linear	E14/E27/B15/B22
G45	clear	230V	4,3W/4,7W/5,2W	470 lm	40W	2700K/4000K/6500K	80/90/95	linear	E14/E27/B15/B22
G45	clear	230V	6,5W	806 lm	60W	2700K/4000K/6500K	80	linear	E14/E27/B15/B22
Dimmable version 									
Bulb type	Finish	Voltage	Watt	Lumen	EQ Watt	CCT	CRI	Driver	Base
G45	clear	230V	2,8W/3,1W/3,4W	250 lm	25W	2700K/4000K/6500K	80/90/95	linear	E14/E27/B15/B22
G45	clear	230V	4,5W/5W/5,5W	470 lm	40W	2700K/4000K/6500K	80/90/95	linear	E14/E27/B15/B22
G45	clear	230V	6,5W	806 lm	60W	2700K/4000K/6500K	80	linear	E14/E27/B15/B22



Certification Northern America



Dimmable version 									
Bulb type	Finish	Voltage	Watt	Lumen	EQ Watt	CCT	CRI	Driver	Base
G16,5	clear	120V	3,5W/2,7W/4,3W	250 lm	25W	2700K/5000K	80/90/95	linear	E12/E26
G16,5	clear	120V	4,5W/3,8W/5,5W	350 lm	40W	2700K/5000K	80/90/95	linear	E12/E26
G16,5	clear	120V	5,5W/5,5W/6,7W	500 lm	60W	2700K/5000K	80/90/95	linear	E12/E26

B35 / B11 Filament LED Lamps

Clear / Amber / Frosted / Milky / Silver Crown



B35/B11 Clear



B35/B11 Amber



B35/B11 Frosted



B35/B11 Milky



B35/B11 Twisted



B35/B11 Twisted

Product Size

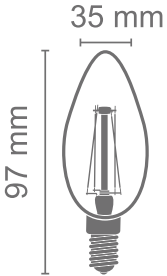

CCT Ref.



B35 / B11 Filament LED Lamps

Clear / Amber / Frosted / Milky / Silver Crown



Certification Europe



Non-dimmable version									
Bulb type	Finish	Voltage	Watt	Lumen	EQ Watt	CCT	CRI	Driver	Base
B35	clear	230V	1,5W/1,7W/1,8W	136 lm	15W	2700K/4000K/6500K	80/90/95	linear	E14/E27/B15/B22
B35	clear	230V	2,2W/2,4W/2,7W	250 lm	25W	2700K/4000K/6500K	80/90/95	linear	E14/E27/B15/B22
B35	clear	230V	4,3W/4,7W/5,2W	470 lm	40W	2700K/4000K/6500K	80/90/95	linear	E14/E27/B15/B22
B35	clear	230V	6,5W	806 lm	60W	2700K/4000K/6500K	80	linear	E14/E27/B15/B22
Dimmable version									
Bulb type	Finish	Voltage	Watt	Lumen	EQ Watt	CCT	CRI	Driver	Base
B35	clear	230V	2,8W/3,1W/3,4W	250 lm	25W	2700K/4000K/6500K	80/90/95	linear	E14/E27/B15/B22
B35	clear	230V	4,5W/5W/5,5W	470 lm	40W	2700K/4000K/6500K	80/90/95	linear	E14/E27/B15/B22
B35	clear	230V	6,5W	806 lm	60W	2700K/4000K/6500K	80	linear	E14/E27/B15/B22



Certification Northern America



Dimmable version									
Bulb type	Finish	Voltage	Watt	Lumen	EQ Watt	CCT	CRI	Driver	Base
B11	clear	120V	4W/3,2W/4,8W	300 lm	40W	2700K/5000K	80/90/95	linear	E12/E26
B11	clear	120V	5,5W/5,5W/6,7W	500 lm	60W	2700K/5000K	80/90/95	linear	E12/E26
Non-dimmable version									
B11	clear	120V	7W/7,7W/8,5W	800 lm	100W	2700K/5000K	80/90/95	linear	E12/E26

BA35 / BA11 Filament LED Lamps

Clear / Amber / Frosted / Milky / Silver Crown



BA35/BA11 Clear



BA35/BA11 Amber



BA35/BA11 Frosted



BA35/BA11 Milky

Product Size

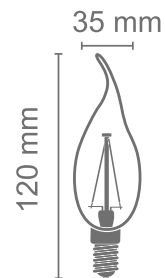

CCT Ref.



BA35 / BA11 Filament LED Lamps

Clear / Amber / Frosted / Milky / Silver Crown



Certification Europe





Non-dimmable version 									
Bulb type	Finish	Voltage	Watt	Lumen	EQ Watt	CCT	CRI	Driver	Base
BA35	clear	230V	1,5W/1,7W/1,9W	136 lm	15W	2700K/4000K/6500K	80/90/95	linear	E14/E27/B15/B22
BA35	clear	230V	2,2W/2,4W/2,7W	250 lm	25W	2700K/4000K/6500K	80/90/95	linear	E14/E27/B15/B22
BA35	clear	230V	4,3W/4,7W/5,2W	470 lm	40W	2700K/4000K/6500K	80/90/95	linear	E14/E27/B15/B22
BA35	clear	230V	6,5W	806 lm	60W	2700K/4000K/6500K	80	linear	E14/E27/B15/B22
Dimmable version 									
Bulb type	Finish	Voltage	Watt	Lumen	EQ Watt	CCT	CRI	Driver	Base
BA35	clear	230V	2,8W/3,1W/3,4W	250 lm	25W	2700K/4000K/6500K	80/90/95	linear	E14/E27/B15/B22
BA35	clear	230V	4,5W/5W/5,5W	470 lm	40W	2700K/4000K/6500K	80/90/95	linear	E14/E27/B15/B22
BA35	clear	230V	6,5W	806 lm	60W	2700K/4000K/6500K	80	linear	E14/E27/B15/B22



Certification Northern America



Dimmable version 									
Bulb type	Finish	Voltage	Watt	Lumen	EQ Watt	CCT	CRI	Driver	Base
BA11	clear	120V	4W/3,2W/4,8W	300 lm	40W	2700K/5000K	80/90/95	linear	E12/E26
BA11	clear	120V	5,5W/5,5W/6,7W	500 lm	60W	2700K/5000K	80/90/95	linear	E12/E26
Non-dimmable version 									
BA11	clear	120V	7W/7,7W/8,5W	806 lm	100W	2700K/5000K	80/90/95	linear	E12/E26

G80/G95/G125 Filament LED Lamps

Clear / Amber / Frosted / Milky / Silver Crown / Gold Crown / Rose Crown



G80 / G95 / G125 Clear



G80 / G95 / G125 Amber



G80 / G95 / G125 Milky



G80 / G95 / G125 Silver crown



G80 / G95 / G125 Gold crown



G80 / G95 / G125 Rose crown

Product Size

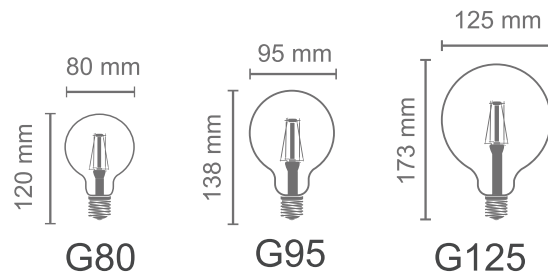

CCT Ref.



G80/G95/G25 Filament LED Lamps

Clear / Amber / Frosted / Milky / Silver Crown



Certification Europe



Non-dimmable version									
Bulb type	Finish	Voltage	Watt	Lumen	EQ Watt	CCT	CRI	Driver	Base
G80/G95/G125	clear	230V	4,3W/4,7W/5,2W	470 lm	40W	2700K/4000K/6500K	80/90/95	linear	E27/B22
G80/G95/G125	clear	230V	7W/7,5W/8,3W	806 lm	60W	2700K/4000K/6500K	80/90/95	linear	E27/B22
G80/G95/G125	clear	230V	8,5W/9,4W/10,3W	1055 lm	75W	2700K/4000K/6500K	80/90/95	linear	E27/B22
G80/G95/G125	clear	230V	10,5W/11,6W/12,8W	1521 lm	100W	2700K/4000K/6500K	80/90/95	SMPS	E27/B22
Dimmable version									
Bulb type	Finish	Voltage	Watt	Lumen	EQ Watt	CCT	CRI	Driver	Base
G80/G95/G125	clear	230V	4,5W/5W/5,5W	470 lm	40W	2700K/4000K/6500K	80/90/95	linear	E27/B22
G80/G95/G125	clear	230V	7W/7,7W/8,5W	806 lm	60W	2700K/4000K/6500K	80/90/95	linear	E27/B22
G80/G95/G125	clear	230V	8,5W/9,4W/10,3W	1055 lm	75W	2700K/4000K/6500K	80/90/95	linear	E27/B22
G80/G95/G125	clear	230V	12W	1521 lm	100W	2700K/4000K/6500K	80	SMPS	E27/B22



Certification Northern America



Dimmable version									
Bulb type	Finish	Voltage	Watt	Lumen	EQ Watt	CCT	CRI	Driver	Base
G25/G30/G40	clear	120V	3,5W/2,7W/4,3W	250 lm	25W	2700K/5000K	80/90/95	linear	E26
G25/G30/G40	clear	120V	4,5W/3,8W/5,5W	350 lm	40W	2700K/5000K	80/90/95	linear	E26
G25/G30/G40	clear	120V	5,5W/6,1W/6,7W	500 lm	60W	2700K/5000K	80/90/95	linear	E26

ST64/ST21 Filament LED Lamps

Clear / Amber



ST64 / ST21 Clear



ST64 / ST21 Amber

Product Size

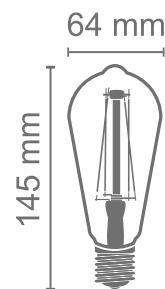

CCT Ref.



ST64/ST21 Filament LED Lamps

Clear / Amber



Certification Europe



Non-dimmable version 									
Bulb type	Finish	Voltage	Watt	Lumen	EQ Watt	CCT	CRI	Driver	Base
ST64	clear	230V	4,3W/4,7W/5,2W	470 lm	40W	2700K/4000K/6500K	80/90/95	linear	E27/B22
ST64	clear	230V	7W/7,5W/8,3W	806 lm	60W	2700K/4000K/6500K	80/90/95	linear	E27/B22
ST64	amber	230V	4,3W/4,7W/5,2W	420 lm	—	2500K	80/90/95	linear	E27/B22
ST64	amber	230V	7W/7,5W/8,3W	720 lm	—	2500K	80/90/95	linear	E27/B22

Dimmable version 									
Bulb type	Finish	Voltage	Watt	Lumen	EQ Watt	CCT	CRI	Driver	Base
ST64	clear	230V	4,5W/5W/5,5W	470 lm	40W	2700K/4000K/6500K	80/90/95	linear	E27/B22
ST64	clear	230V	7W/7,7W/8,5W	806 lm	60W	2700K/4000K/6500K	80/90/95	SMPS	E27/B22
ST64	amber	230V	4,5W/5W/5,5W	420 lm	—	2500K	80/90/95	linear	E27/B22
ST64	amber	230V	7W/7,5W/8,3W	720 lm	—	2500K	80/90/95	linear	E27/B22



Certification Northern America



Dimmable version 									
Bulb type	Finish	Voltage	Watt	Lumen	EQ Watt	CCT	CRI	Driver	Base
ST21	clear	120V	4,5W/3,2W/5,5W	300 lm	40W	2700K/5000K	80/90/95	linear	E26
ST21	clear	120V	5,5W/5,5W/6,7W	500 lm	60W	2700K/5000K	80/90/95	linear	E26

T25 / T28 Filament LED Lamps

Clear / Amber / Milky



T25 Clear



T25 Amber



T45 Clear



T28 Clear



T28 Amber



T28 Clear



T28 Amber

Product Size

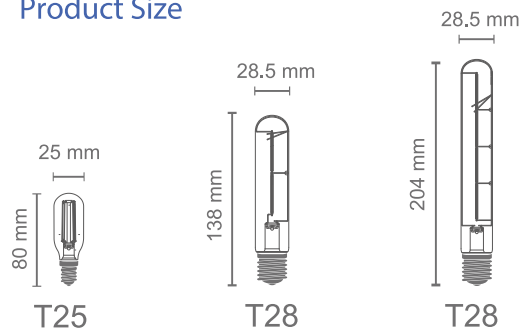

CCT Ref.



T25 / T28 Filament LED Lamps

Clear / Amber / Milky



Certification Europe



Non-dimmable version 									
Bulb type	Finish	Voltage	Watt	Lumen	EQ Watt	CCT	CRI	Driver	Base
T25	clear	230V	1,5W/1,7W/1,8W	136 lm	15W	2700K/4000K/6500K	80/90/95	linear	E14/B15
T25	clear	230V	2,2W/2,4W/2,7W	250 lm	25W	2700K/4000K/6500K	80/90/95	linear	E14/B15
T25	clear	230V	4,3W/4,7W/5,2W	470 lm	40W	2700K/4000K/6500K	80/90/95	linear	E14/B15
T28	clear	230V	2,2W/2,4W/2,7W	250 lm	25W	2700K/4000K/6500K	80/90/95	linear	E27/B22
T28	clear	230V	4,3W/4,7W/5,2W	470 lm	40W	2700K/4000K/6500K	80/90/95	linear	E27/B22

Dimmable version 									
Bulb type	Finish	Voltage	Watt	Lumen	EQ Watt	CCT	CRI	Driver	Base
T25	clear	230V	2,8W/3,1W/3,4W	250 lm	25W	2700K/4000K/6500K	80/90/95	linear	E14/B15
T25	clear	230V	4,5W/5W/5,5W	470 lm	40W	2700K/4000K/6500K	80/90/95	linear	E14/B15
T28	clear	230V	2,8W/3,1W/3,4W	250 lm	25W	2700K/4000K/6500K	80/90/95	linear	E27/B22
T28	clear	230V	4,5W/5W/5,5W	470 lm	40W	2700K/4000K/6500K	80/90/95	linear	E27/B22



Certification Northern America



Dimmable version 									
Bulb type	Finish	Voltage	Watt	Lumen	EQ Watt	CCT	CRI	Driver	Base
T9	clear	120V	2,5W/1,5W/3W	150 lm	25W	2700K/5000K	80/90/95	linear	E26
T9	clear	120V	4W/3,2W/4,9W	300 lm	40W	2700K/5000K	80/90/95	linear	E26

S26 / S45 / S14 Filament LED Lamps

Clear / Amber



S26 clear



S45 clear



S45 Amber

Product Size

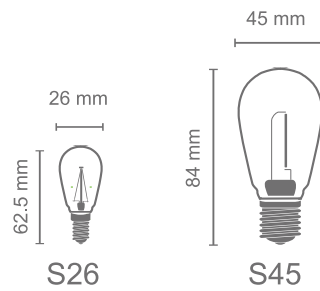

CCT Ref.



S26 / S45 / S14 Filament LED Lamps

Clear / Amber



Certification Europe



Non-dimmable version 									
Bulb type	Finish	Voltage	Watt	Lumen	EQ Watt	CCT	CRI	Driver	Base
S26	clear	230V	1,3W	110 lm	—	2700K/4000K/6500K	80	RC	E14/B15
S26	clear	230V	2,2W/2,4W/2,7W	250 lm	25W	2700K/4000K/6500K	80/90/95	linear	E14/E27/B15/B22
S45	clear	230V	1,5W/1,7W/1,8W	136 lm	15W	2700K/4000K/6500K	80/90/95	linear	E14/E27/B15/B22
S45	clear	230V	2,2W/2,4W/2,7W	250 lm	25W	2700K/4000K/6500K	80/90/95	linear	E14/E27/B15/B22
S45	clear	230V	4,3W/4,7W/5,2W	470 lm	40W	2700K/4000K/6500K	80/90/95	linear	E14/E27/B15/B22
Dimmable version 									
Bulb type	Finish	Voltage	Watt	Lumen	EQ Watt	CCT	CRI	Driver	Base
S45	clear	230V	2,8W/3,1W/3,4W	250 lm	25W	2700K/4000K/6500K	80/90/95	linear	E14/E27/B15/B22
S45	clear	230V	4,5W/5W/5,5W	470 lm	40W	2700K/4000K/6500K	80/90/95	linear	E14/E27/B15/B22



Certification Northern America



Non-dimmable version 									
Bulb type	Finish	Voltage	Watt	Lumen	EQ Watt	CCT	CRI	Driver	Base
S14	amber	120V	1,5W	90 lm	15W	2200K	80	linear	E26

R50 / R60 / R63/ R80 Filament LED Lamps

Silver



R39 Silver



R50 Silver



R63 Silver



R80 Silver

Product Size

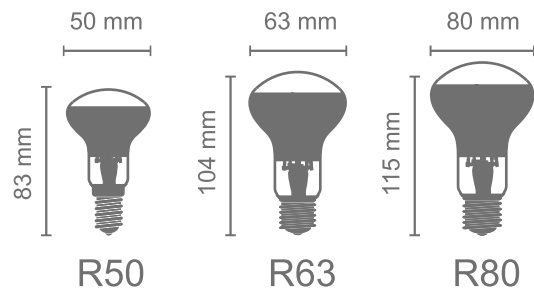

CCT Ref.



R50 / R60 / R63/ R80 Filament LED Lamps

Silver



Certification Europe



Non-dimmable version 								
Bulb type	Finish	Voltage	Watt	Lumen	CCT	CRI	Driver	Base
R39	silver	230V	1,5W/1,7W/1,8W	110 lm	2700K/4000K/6500K	80/90/95	linear	E14/B15
R50	silver	230V	1,5W/1,7W/1,8W	110 lm	2700K/4000K/6500K	80/90/95	linear	E14/B15
R50	silver	230V	2,2W/2,4W/2,7W	180 lm	2700K/4000K/6500K	80/90/95	linear	E14/B15
R63	silver	230V	2,2W/2,4W/2,7W	180 lm	2700K/4000K/6500K	80/90/95	linear	E27/B22
R63	silver	230V	4,3W/4,7W/5,2W	380 lm	2700K/4000K/6500K	80/90/95	linear	E27/B22
R80	silver	230V	4,3W/4,7W/5,2W	380 lm	2700K/4000K/6500K	80/90/95	linear	E27/B22
R80	silver	230V	7W/7,7W/8,5W	620 lm	2700K/4000K/6500K	80/90/95	linear	E27/B22

